



ELECTRIC HOT PLATE MG-2/MG-4

MANUAL

IMPORTANT:

THE USER'S MANUAL PROVIDES SPECIFIC OPERATING INSTRUCTIONS FOR YOUR MODEL. USE THE ELECTRIC HOT PLATE ONLY AS INSTRUCTED IN THIS MANUAL.

KEEP A COPY OF YOUR BILL OF SALE.

The date on the bill establishes the warranty period should service be required. If service is performed, it is in your interest to obtain and keep all receipts.

KEEP THIS MANUAL FOR TRAINING NEW PERSONNEL.

Record the Serial number and Model number of this Electric Hot Plate in the spaces provided. **Keep these numbers for future reference.**

SERIAL NUMBER

MODEL NUMBER

Keating commercial Hot Plates are not intended for household use.

As continuous product improvement occurs, specifications may be changed without notice.

1-800-KEATING | keatingofchicago.com

NOTE:

PURCHASER SHOULD POST IN A PROMINENT LOCATION.

THIS EQUIPMENT MUST BE SECURELY ATTACHED TO A RIGID STRUCTURE BEFORE OPERATION. INSTALLER: DO NOT CONNECT ELECTRICITY TO THIS UNIT BEFORE IT IS SECURED TO PREVENT TIPPING.

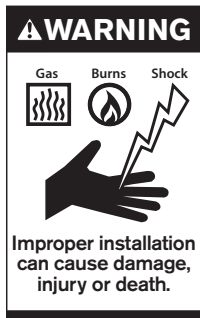

⚠ WARNING

Improper installation, adjustment, alteration, service or maintenance can cause property damage, injury or death. Read the installation, operating and maintenance instructions thoroughly before installing or servicing this equipment.



FOR YOUR SAFETY:

Do not store or use gasoline or other flammable vapors or liquids in the vicinity of this or any other appliance.

⚠ WARNING

IF NOT INSTALLED, OPERATED AND MAINTAINED IN ACCORDANCE WITH THE MANUFACTURER'S INSTRUCTIONS, THIS PRODUCT COULD EXPOSE YOU TO SUBSTANCES IN FUEL OR IN FUEL COMBUSTION WHICH CAN CAUSE DEATH OR SERIOUS ILLNESS AND WHICH ARE KNOWN TO THE STATE OF CALIFORNIA TO CAUSE CANCER, BIRTH DEFECTS OR OTHER REPRODUCTIVE HARM.



■ TABLE OF CONTENTS

Important Safety Instructions	i
INTRODUCTION	1
INSTALLATION	
Damage During Shipment	1
Standard Features	2
Options	2
Safety Precautions	2
FIRST STEPS	
National Code Requirement	2
Positioning	2
Restraining Devices	3
Electrical Connection	3

PLACING YOUR KEATING HOT PLATE IN OPERATION

Lighting	3
Shutdown	3
Cleaning	3
PREVENTATIVE MAINTENANCE	
Warranty Repairs	3
Preventive Maintenance Chart	3
ORDERING PARTS	4
Warning and Operating Plates	4
Parts List	4
WIRING DIAGRAMS	5 - 11
Warranty Information	12

■ INTRODUCTION

Instructions in this manual should be read thoroughly before attempting to operate the Keating Electric Hot Plate. All installation and service on Keating equipment must be performed by qualified, certified, licensed and/or authorized installation or service personnel.

Operating information for Keating equipment has been prepared for use by qualified and/or authorized personnel.

Keating equipment is made in the USA and has American sizes of hardware. All metric conversions are approximate.

■ INSTALLATION INSTRUCTIONS

Proper installation will assure top performance. Alterations of any kind to your equipment will void the warranty. Before uncrating, check equipment carefully for damage.

IF EQUIPMENT ARRIVES DAMAGED

Keating does not assume responsibility for loss or damage incurred in transit.

IMPORTANT

This merchandise has been thoroughly inspected and carefully packed before leaving our plant. Responsibility for its safe delivery was assumed by the carrier at the time of shipment. Claims for loss or damage to the contents should, therefore, be made upon the carrier, as follows:

CONCEALED LOSS OR DAMAGE

Concealed loss or damage means loss or damage which does not become apparent until the merchandise has been unpacked. The contents may be damaged in transit due to rough handling even though

the carton may not show external damage. When the damage is discovered upon unpacking, make a written request for inspection by the carrier's agent within fifteen days of the delivery date. Then file a claim with the carrier since such damage is the carrier's responsibility. By following these instructions carefully, we guarantee our full support of your claims to protect you against loss from concealed damage.

VISIBLE LOSS OR DAMAGE

Any external evidence of loss or damage must be noted on the freight bill or express receipt, and signed by the carrier's agent. Failure to adequately describe such external evidence of loss or damage may result in the carrier refusing to honor a damage claim. The form required to file such a claim will be supplied by the carrier.

DO NOT RETURN DAMAGED MERCHANDISE TO KEATING. FILE YOUR CLAIM AS STATED ABOVE.

Keating MG-2 and MG-4 Hot Plates are designed to give maximum production efficiency, delivering high quality food products. The following design features are incorporated in all Keating Hot Plates.

STANDARD FEATURES

- Highly polished stainless steel front
- Infinite controls
- 12" working height
- Heating elements with pans
- Easy access for servicing
- 100% factory testing

MODEL VARIATIONS

MG-2 Model: The MG-2 model has two elements

MG-4 Model: The MG-4 model has four elements

SAFETY PRECAUTIONS

⚠ WARNING

THIS SYMBOL WARNS YOU THAT SERIOUS BURNS OR OTHER INJURIES MAY RESULT IF SAFETY INSTRUCTIONS ARE NOT FOLLOWED.

- This service manual should be retained in a safe place for future reference. The installation of your new hot plate must conform to local codes or in the absence of local codes, with the current National Fuel National Electrical Code ANSI/NFPA 70 or Canadian Electrical Code CAN 22.2 as applicable.
- Your ventilation hood, when installed, must conform to the current ANSI/NFPA 96 standard (latest edition).
- No frame or restriction shall be constructed around the hot plate that will restrict air movement or prevent proper ventilation.
- Suitable for installation on combustible surfaces.
- You must maintain this appliance free and clear from combustibles.
- You must maintain the following minimum clearances from combustible and non-combustible construction:

MINIMUM CLEARANCE

CONSTRUCTION CLEARANCES		
	COMBUSTIBLE	NON-COMBUSTIBLE
BACK	6"	0"
RIGHT SIDE	6"	0"
LEFT SIDE	6"	0"

- You must install this appliance at least 16 inches away from any open flame.
- Adequate clearance for servicing and proper operation must be maintained. Your hot plate is designed to be serviced from the front.
- Keating commercial hot plates are not intended for household use. Installation in households voids warranty.
- ALWAYS instruct new employees on proper hot plate operation.
- A hot plate should be operated ONLY by properly trained personnel.
- ALWAYS turn hot plate off each night.
- ALWAYS disconnect electrical supply before servicing.
- NEVER leave a hot plate unattended during operation.
- NEVER introduce objects into hot plate, while operational, which are not designed or made for cooking.
- THIS HOT PLATE MAY NOT BE ALTERED, MODIFIED OR CHANGED IN ANY WAY.

Safe operation of this equipment is possible only when the operating instructions and the safety precautions are read completely and the instructions contained therein are strictly observed. Before operating this equipment, ask for a practical demonstration.

Periodically inspect cable and plug, if provided, before using machine. Servicing should be performed by qualified and licensed service companies.

This hot plate MUST be installed, inspected, and serviced by qualified and/or certified and/or licensed service personnel – you may void your Keating warranty if installation is not completed per current local, national and Keating specifications. Contact your dealer for assistance.

■ FIRST STEPS

NATIONAL CODE REQUIREMENT

Installation must conform with local codes or, in absence of local codes, with the current National Electrical Code ANSI/NFPA 70 or Canadian Electrical Code CAN22.2 as applicable.

POSITIONING

The hot plate must be placed under an exhaust hood with a fire retardant system. Your ventilation hood, when installed, must conform to the current ANSI/NFPA 96 standard. ALL connections and placement must comply with local and national codes. It is the responsibility of the owner and local installer to comply with these regulations when installing the hot plate.

NOTE: NOT FOR OUTDOOR INSTALLATION

RESTRAINING DEVICES

Hot plates **must be restrained to prevent tipping** when installed in order to avoid splashing, spilling, etc. of hot liquid. The restraining method may be a manner of installation or by separate means. Adequate means must also be provided to limit the movement of the appliance.

⚠ WARNING

IF DISCONNECTION OF THE RESTRAINT IS NECESSARY, IT MUST BE RECONNECTED WHEN THE HOT PLATE IS RETURNED TO ITS ORIGINALLY INSTALLED POSITION.

ELECTRICAL CONNECTION

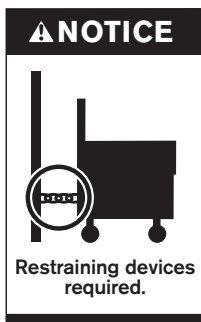

The Keating Electric Hot Plate is equipped with a three wire terminal block for customer connections. Compare the hot plate terminal connections to the appropriate wiring diagram for the hot plate (see pages 6-11 Wiring Diagram) to see if the hot plate is connected three phase or single phase. All wires, cords, plugs, receptacles and circuit breakers must be sized

adequately for the full load rating of the hot plate as specified by local codes or, in the absence of local codes, by the current National Electrical Code ANSI/NFPA 70 or the Canadian Electrical Code CAN 22.2 as applicable.

The electric hot plate is also equipped with a grounding lug next to the terminal block. For proper grounding procedures, see local codes or, in the absence of local codes, the current National Electrical Code ANSI/NFPA 70 or the Canadian Electrical Code CAN 22.2 as applicable.

NOTE: The connections to the hot plate can be changed in the field from three phase to single phase or from single phase to three phase. This can be done by simply changing the wiring at the terminal block. To change the connections for your hot plate, see the wiring diagram for your model on pages 6-11.

NOTE: For hot plates rated at 208-240 volts, the amperage ratings marked on the nameplates of the hot plates are listed at 240 volts as required by UL.

NOTE: A hole has been punched in the rear of the hot plate cabinet for a cord or conduit exit. If a cord is used, the National Electrical Code, UL standards and most local codes require a bushing or strain relief (not provided by Keating) to protect the cord.

■ OPERATING

LIGHTING

Keating hot plates are designed to provide maximum efficiency and deliver high quality food products. Follow lighting procedure as listed.

⚠ WARNING

OPERATION OF THIS HOT PLATE SHOULD BE LIMITED TO PERSONNEL WHO HAVE BEEN THOROUGHLY TRAINED IN OPERATING PROCEDURES.

1. Push in the red knob and rotate it fully counter clockwise to the desired setting.

NOTE: The left knob operates the back burner and the right knob operates the front burner.

SHUTDOWN

1. Rotate the red knob fully clockwise for each burner.

CLEANING

When cleaning your hot plate, use Keating Klenzer, the finest dry stainless steel polish available, to restore your hot plate's exterior to its original luster.

⚠ CAUTION

Disconnect the electrical power source before doing any cleaning.

WARRANTY REPAIRS

Keating's warranty begins with the date of installation. In the event that your hot plate, under warranty, needs repairs other than routine maintenance or cleaning, you are required to contact Keating of Chicago (at 1-800-KEATING) before calling a local service company.

PREVENTIVE MAINTENANCE

Preventive maintenance should be done in daily, weekly, monthly and yearly intervals as necessary. Following preventive maintenance procedures will help keep your hot plate working efficiently. Proper care and servicing will lead to years of quality performance.

PREVENTATIVE MAINTENANCE CHART

TIME FRAME	OPERATOR/OWNER
AT LEAST DAILY*	<ul style="list-style-type: none"> • Check controls. • Drain and clean drip pan.
AT LEAST WEEKLY*	<ul style="list-style-type: none"> • Clean hot plate

*High production facilities should be checked more often. Contact the factory or a local service company to perform maintenance and repairs.

■ ORDERING PARTS

Parts may be ordered by calling 1-800-KEATING or your local Keating service company. We recommend using genuine Keating Replacement Parts - engineered and manufactured specifically to meet exact specifications and requirements for Keating equipment.

Refer to the Keating Hot Plate Limited Warranty for complete service and ordering information.

The model/serial plate is located on the front of the control panel. The serial and model numbers are necessary when ordering.

WARNING AND OPERATING PLATES

All warning and operating plates on the Keating Electric Hot Plate should be in place at all times. If plates are damaged or lost, replace them immediately.

■ PARTS LIST - ELECTRIC HOT PLATE

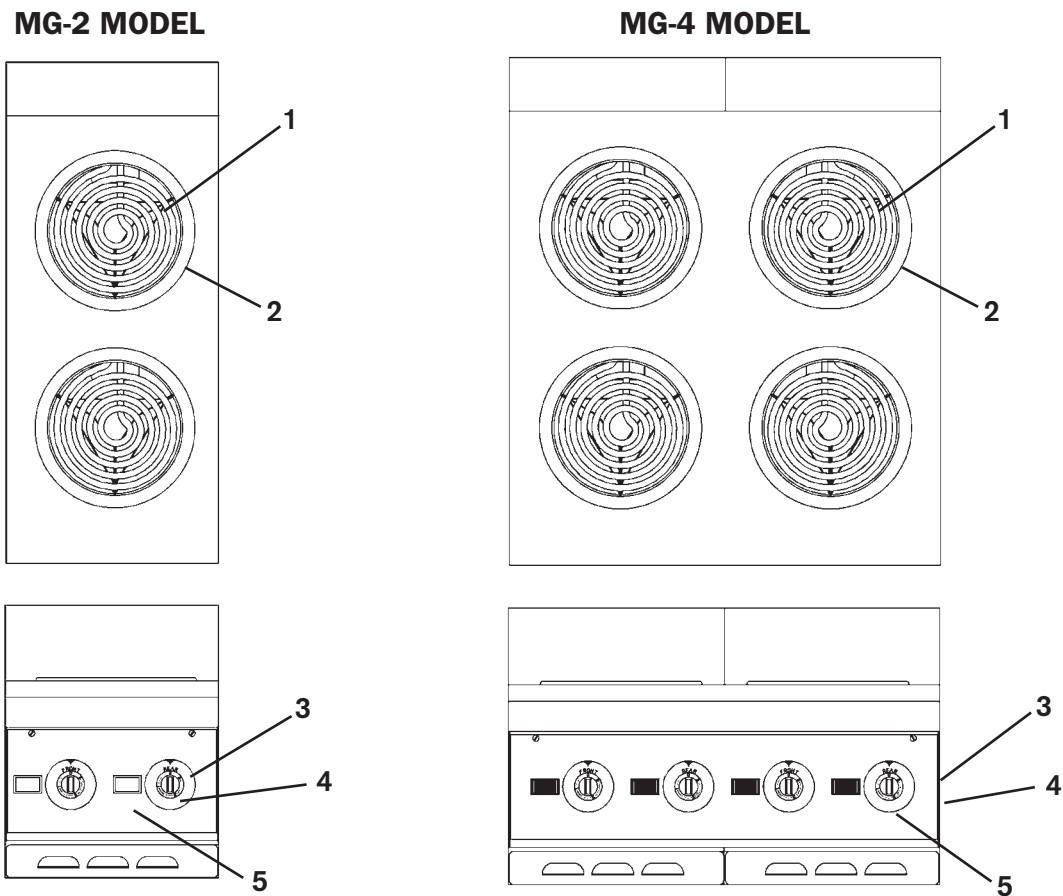

ITEM	DESCRIPTION	PART #	MG-2	MG-4
			Quantity Per Model	
1	ELEMENT 240V 2600W WITH PAN	037586	2	4
2	ELEMENT PAN ONLY	037378	2	4
2	ELEMENT RING ONLY	039233	2	4
3	INFINITE CONTROL	011614	2	4
4	INFINITE CONTROL KNOB ONLY	037587	2	4
5	INDICATING LIGHT, AMBER, 240V	050255	2	4
6	TERMINAL BLOCK (NOT SHOWN)			
	208- 240 VOLT UNITS	034381	1	2
	FOR 480 VOLT UNITS	026241	4	
7	CONTACTORS (NOT SHOWN)	011184	2	4
8	RESISTORS (NOT SHOWN)	037308	4	8
9	TRANSFORMERS (NOT SHOWN)			
	240/480V PRIMARY 120/240 SECONDARY	059433	1	1
	440-220V PRIMARY 220-110V SECONDARY	059603	1	2

■ WIRING DIAGRAMS

MG-2 208- 240 VOLT SINGLE PHASE

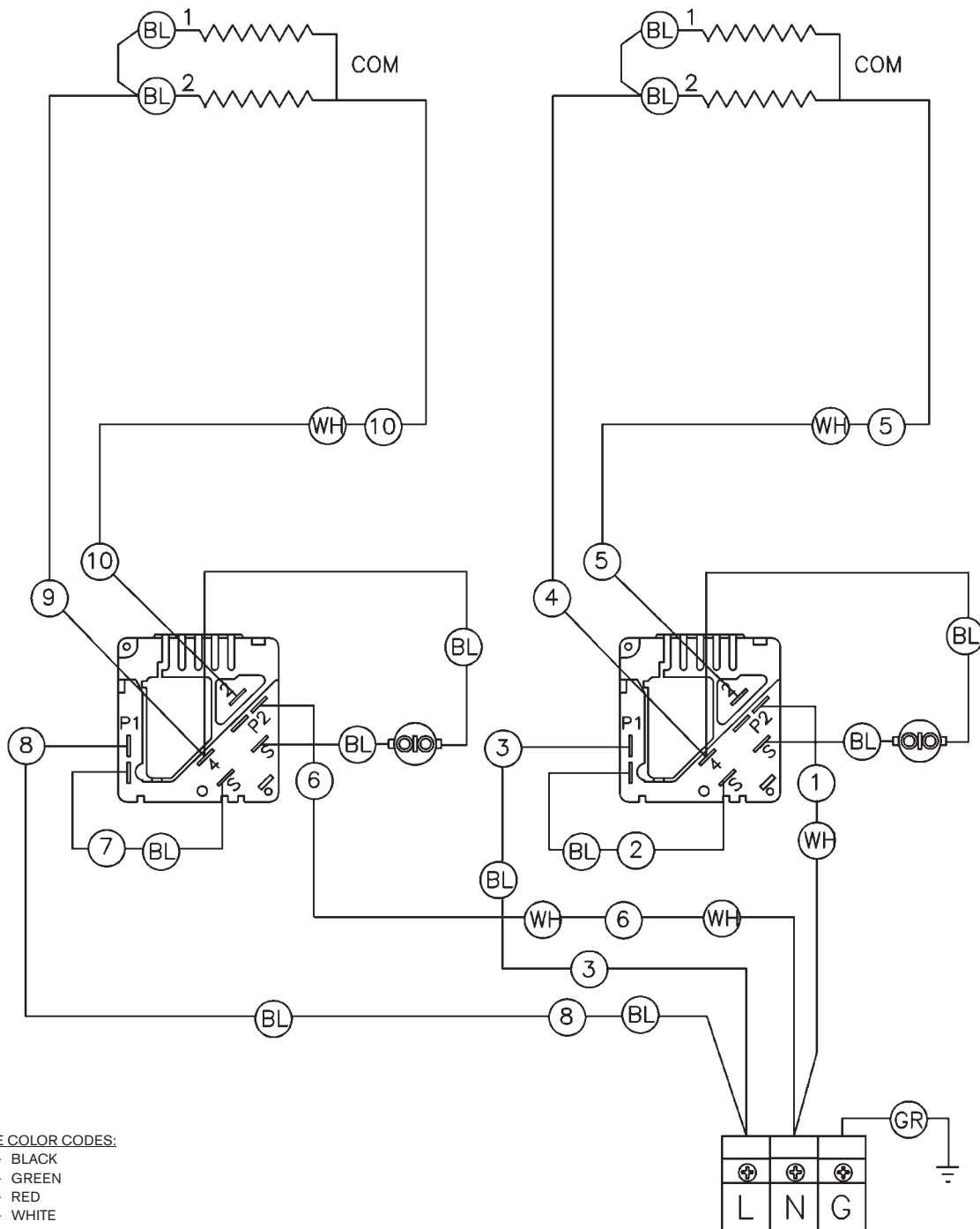

MG-2 208- 240 VOLT 3 PHASE

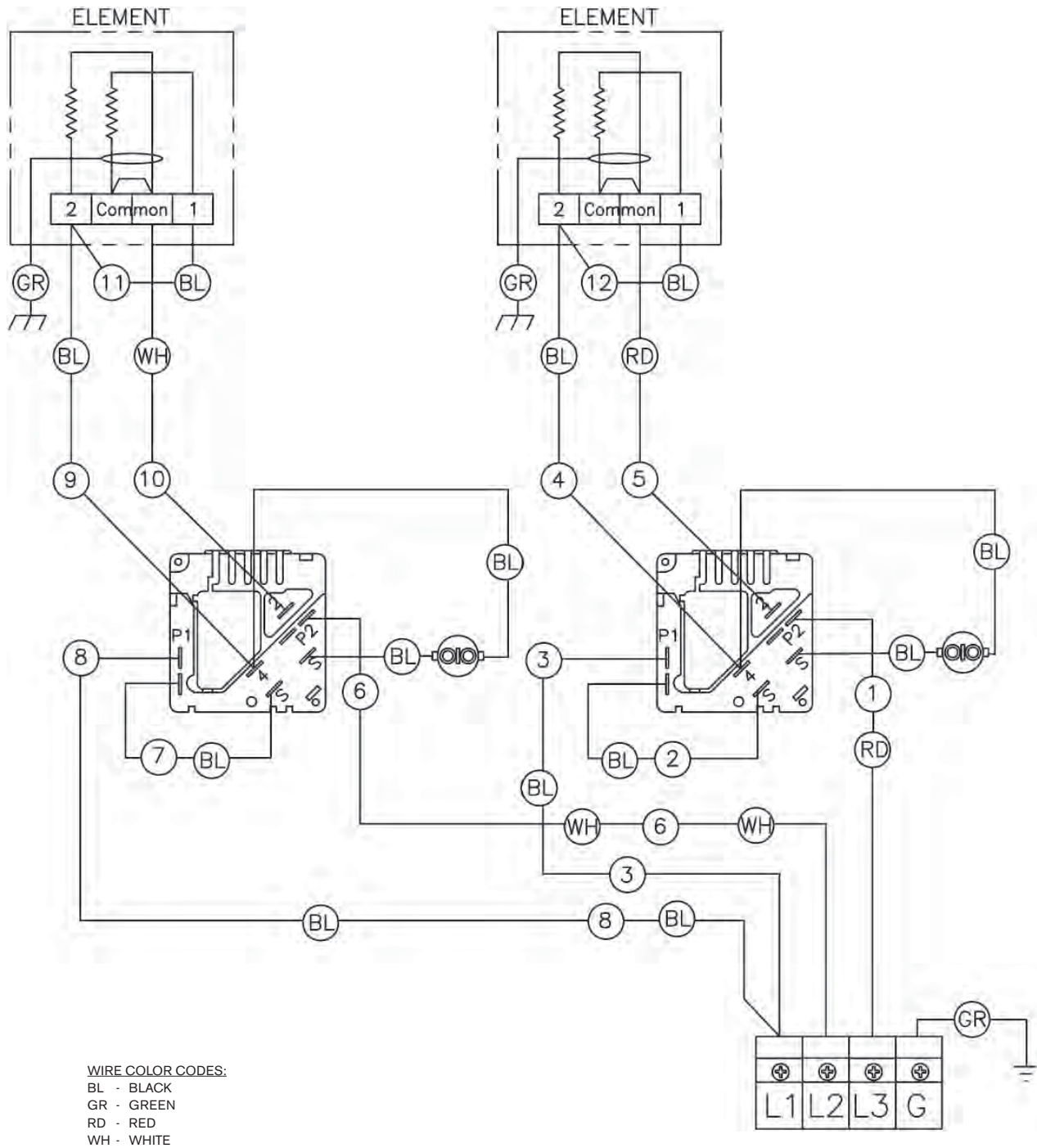

MG-2 480 VOLT SINGLE PHASE WITH RESISTORS FOR 240V HEATING ELEMENTS

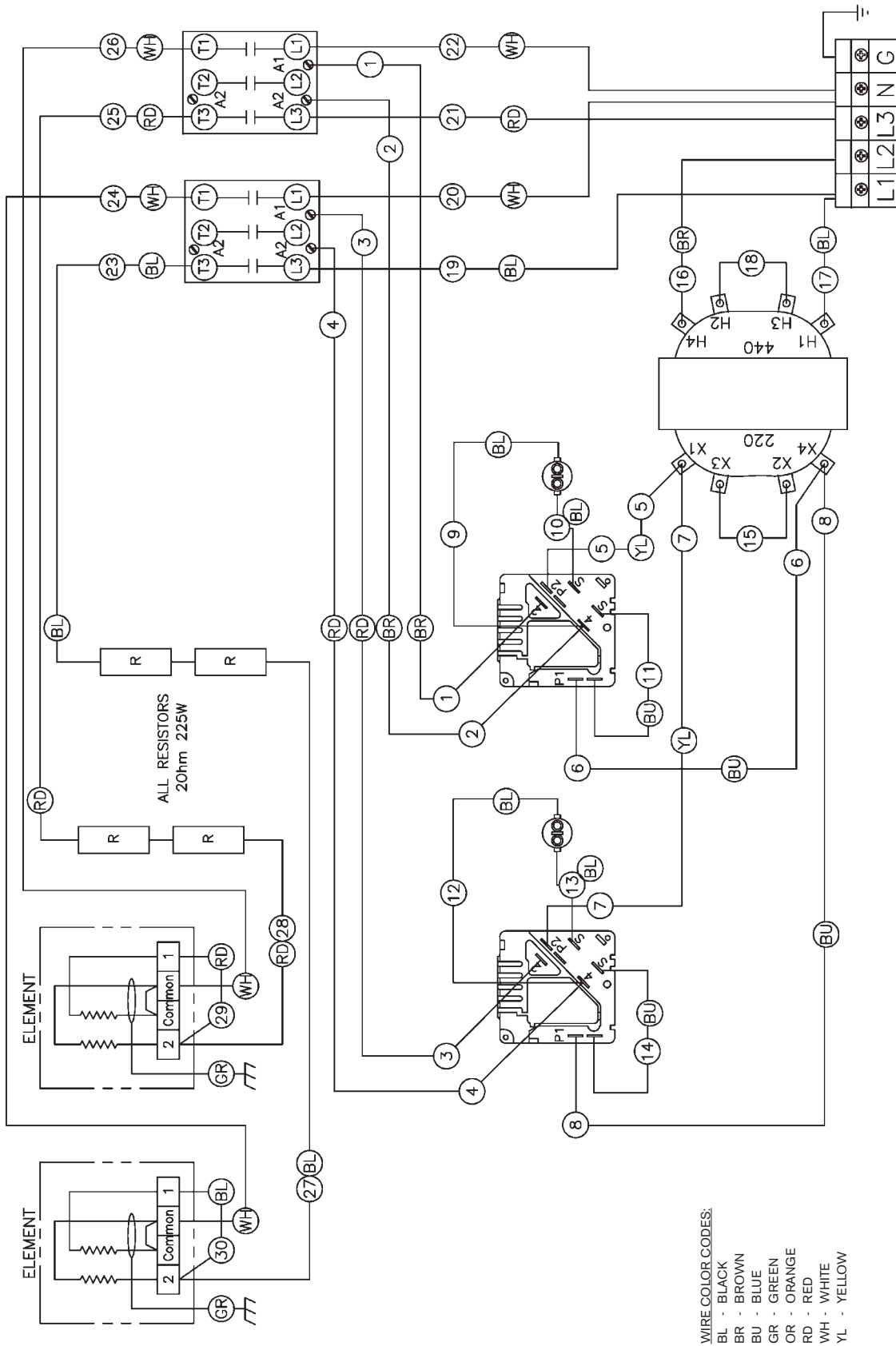

MG-2 480 VOLT 3 PHASE WITHOUT RESISTORS FOR 240V HEATING ELEMENTS

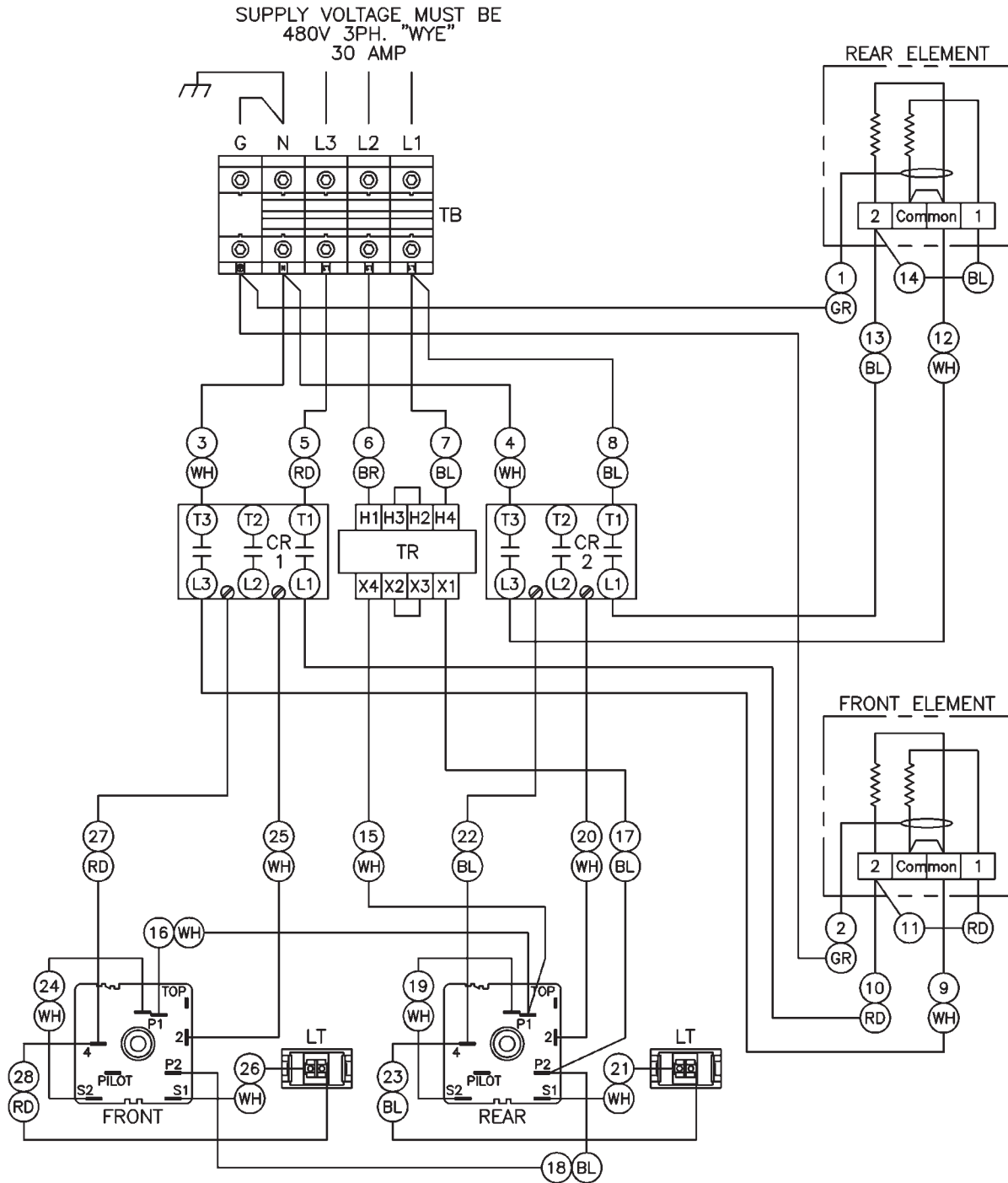

WIRE COLOR CODES:

- BL - BLACK
- BR - BROWN
- GR - GREEN
- RD - RED
- WH - WHITE

COMPONENT CODES:

- CR - CONTACTOR 240VAC
- LT - LIGHT (AMBER)
- TB - TERMINAL BLOCK
- TR - TRANSFORMER

MG-4 208- 240 VOLT SINGLE PHASE

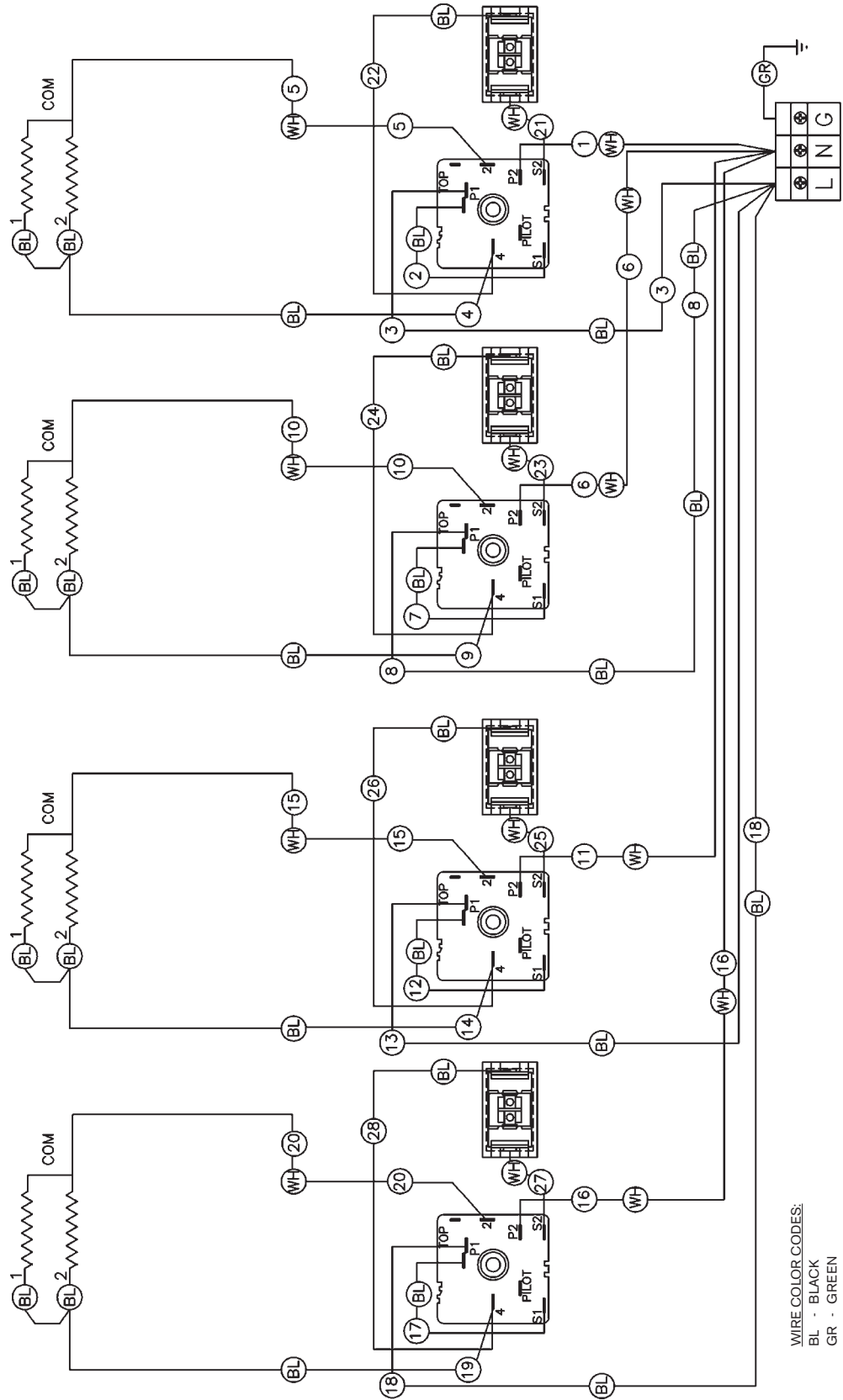

WIRE COLOR CODES:
 BL - BLACK
 GR - GREEN
 WH - WHITE

MG-4 208- 240 VOLT 3 PHASE

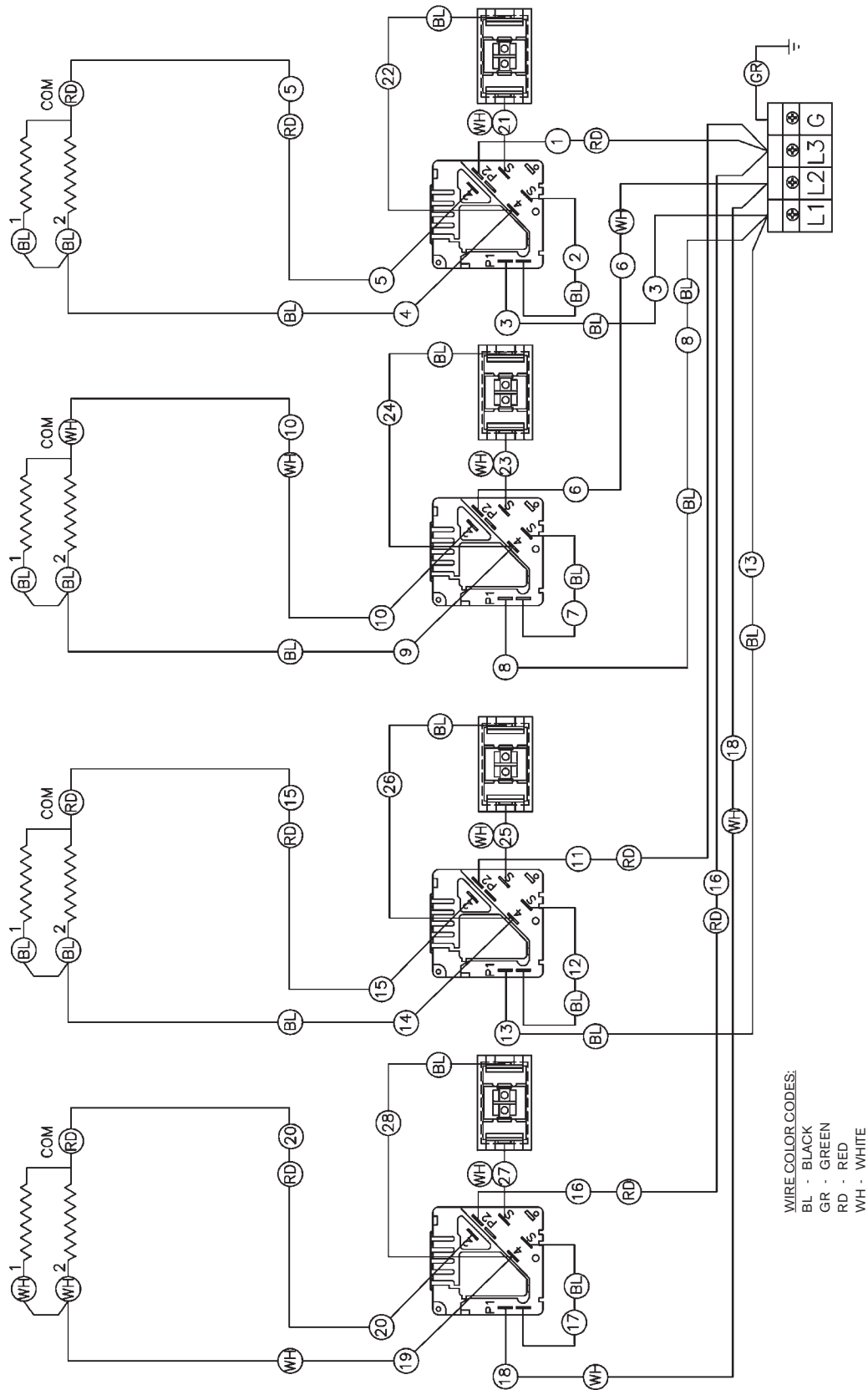



WARRANTY

LIMITED WARRANTY

Keating of Chicago, Inc. ("Keating") warrants to the original purchaser, ("Customer"), all new Keating Fryers, Filter Systems, Griddles, Keep Krisp[®], Custom Pasta Systems, Top-Side[™] Cookers, Computer Timers, Fryer & Pasta Vessels and Keating replacement parts ("products") installed after June 1, 1994 to be free of defects in material or workmanship, subject to the following terms and conditions.

LENGTH OF WARRANTY

All products other than Fryer & Pasta Vessels and replacement parts shall be warranted for a period of one year from the date of original equipment installation. Keating replacement parts are warranted for a period of ninety days from the date of installation. Fryer & Pasta Vessels are warranted as described below.

FRYER & PASTA VESSEL WARRANTY

Fryers purchased after June 1, 1994 carry a prorated vessel warranty on defects in materials or workmanship to the Customer based on the following scale:

Time from Installation Date	Fryer Vessel Warranty Credit
13-60 months	100%
61-72 months	80%
73-84 months	60%
85-96 months	40%
97-108 months	20%
109-120 months	10%

The credit for the defective fryer & pasta vessel shall be applied against the cost of the replacement vessel, utilizing Keating's then current price, upon return of the vessel to Keating only during the first 60 months, subject to the limitations described below.

LIMITATIONS OF LIABILITY

In the event of warranty claim or otherwise, the sole obligation of Keating shall be the repair and / or replacement at the option of Keating of the product or component part thereof. Such repair or replacement shall be at the expense of Keating except that the Customer shall pay the following expenses: all freight and labor expense for Keating replacement parts; for all other products, mileage exceeding 50 miles or travel more than one hour, labor costs of more than one person, overtime rates, truck charges, difference between ground and other mode of transportation, and holiday charges. Any repair or replacement under this Limited Warranty does not constitute an extension of the original warranty for any period for the product or for any component or part thereof. Parts to be replaced under this Limited Warranty will be repaired at the option of Keating with new or functionally operative parts. Keep Krisps and Computer Timers must be returned to Keating for warranty repair or replacement. Field repairs of those items are not authorized.

THE LIABILITY OF KEATING ON ANY CLAIM OF ANY KIND, INCLUDING CLAIMS BASED ON WARRANTY, EXPRESSED OR IMPLIED, CONTRACT, NEGLIGENCE, STRICT LIABILITY OR ANY OTHER THEORIES SHALL BE SOLELY AND EXCLUSIVELY THE REPAIR OR REPLACEMENT OF THE PRODUCT AS STATED HEREIN, AND SUCH LIABILITY SHALL NOT INCLUDE, AND CUSTOMER SPECIFICALLY RENOUNCES ANY RIGHTS TO RECOVER, SPECIAL, INCIDENTAL, CONSEQUENTIAL OR OTHER INJURIES TO PERSONS OR DAMAGE TO PROPERTY, LOSS OF PROFITS OR ANTICIPATED PROFITS, OR LOSS OF USE OF THE PRODUCT.

If any oral statements have been made regarding the Keating products, such statements do not constitute warranties and are not part of the contract sale. This Limited Warranty constitutes the complete, final and exclusive statement with regard to warranties.

THIS LIMITED WARRANTY IS EXCLUSIVE AND IS IN LIEU OF ALL OTHER WARRANTIES WHETHER WRITTEN, ORAL, STATUTORY OR IMPLIED, INCLUDING BUT NOT LIMITED TO ANY WARRANTY OF MERCHANTABILITY OR FITNESS FOR PARTICULAR PURPOSE OR WARRANTY AGAINST LATENT DEFECTS.

EXCLUSIONS

The warranties provided by Keating of Chicago, Inc. do not apply in the following instances:

1. Defects arising out of or resulting from improper installation or maintenance, abuse, misuse, modification or alteration by unauthorized service personnel, or any other condition not attributable to a defect in material or workmanship. Proper installation and maintenance are the responsibility of the installer and Customer, respectively. Proper installation and maintenance procedures are prescribed by the Keating Service Manual.
2. In the event that the product was damaged after leaving the factory due to flood, fire, other acts of God or accident, damaged during shipment should be reported to the carrier and is not the responsibility of Keating.
3. In the event the serial number or rating plate has been removed from the product or altered.
4. On parts which would normally be worn or replaced under normal conditions, including but not limited to electric bulbs, fuses, interior and exterior finishes, gaskets and radiants.
5. With regard to adjustments and calibrations such as leveling, tightening of fasteners or plumbing connections, improper gas pressure or improper electrical supply, the checking of and changes in adjustment and calibrations are the responsibility of the installer. Proper installation procedures are prescribed by the Keating Service Manual.
6. In the event of unauthorized repairs or alterations to the Keating product.
7. With the use of sodium chloride in pasta vessels or harsh chemicals in fryer or pasta vessels.
8. Installation in Household.

OTHER TERMS AND CONDITIONS

The Customer must provide proof of purchase from Keating.

This Limited Warranty is valid in the 50 United States, its territories, and Canada, and is void elsewhere. Keating products are sold for commercial use only. If any Keating product is sold as a component of another product or used as a consumer product, such Keating product is sold As Is without any warranty.

If any provision of this Limited Warranty is held to be unenforceable under the law of any jurisdiction, such provision shall be inapplicable in such jurisdiction, and the remainder of the warranty shall remain unaffected. Further in such event, the maximum exclusion or limitation allowable under applicable law shall be deemed substituted for the unenforceable provision.

This Limited Warranty shall be governed by and construed in accordance with the laws of the State of Illinois.

TO SECURE WARRANTY SERVICE

All repair services under this Limited Warranty must be authorized by Keating or performed at Keating. Authorization may be obtained by calling 1-800-KEATING within the Continental United States, Alaska, Hawaii, Puerto Rico and Canada during normal business hours (8 a.m. through 5 p.m. Central Time, Monday through Friday). When calling, please have the following information available: (1) name, address and telephone number of the Customer; (2) location of product, if different; (3) name, model number and serial number of the product; (4) installation date; and (5) description of defect. Keating will then issue a service authorization work order number to one of its approved independent servicing organizations, or request the product or part be shipped to Keating for repair or replacement, as appropriate. Any defective part subject to a claim under this Limited Warranty must be shipped freight prepaid to Keating for testing and examination. Keating's decision as to the cause and nature of any defect under this Limited Warranty shall be final.

■ **SERVICE INFORMATION:**

If you have a service related question call **1-800-KEATING**.
Please state the nature of the call; it will ensure speaking with the appropriate person.

Have your serial and model number available when ordering parts.

As continuous product improvement occurs, specifications may be changed without notice.

.....
KEATING LIMITED WARRANTY CARD

PLEASE COMPLETE AND MAIL AT ONCE--WARRANTY IS NOT IN EFFECT UNTIL CARD IS RETURNED, OR COMPLETE THE WARRANTY CARD ON OUR WEBSITE FOR YOUR CONVENIENCE.

COMPANY: _____

ADDRESS: _____

CITY: _____ STATE: _____ ZIP CODE: _____

DEALER NAME: _____

DATE OF PURCHASE: _____ INVOICE #: _____

SERIAL #: _____ MODEL: _____

FRYER GRIDDLE CUSTOM PASTA
 FILTER SYSTEM TOP-SIDE COOKER HOTPLATE

I HAVE READ THE INSTALLATION AND OPERATING INSTRUCTIONS.

SIGNED: _____ DATE: _____



KEATING OF CHICAGO, INC.
8901 West 50th Street
McCook, IL 60525-6001

1-800-KEATING
PHONE: 708-246-3000
FAX: 708-246-3100

Serving Those Who Serve the Very Best®